

Assembly instructions Planetary Gearbox GPL080

1. Glue motor pinion onto motor shaft and secure with dowel pin

Recommended adhesive: LOCTITE 638

- 1.1. Verify concentricity of motor shaft
 - Maximum concentricity of the motor shaft: 0.02mm
- 1.2. Verify fit of motor shaft to pinion bore
 - Tolerance of bore of pinion: H7
 - Optimal play shaft to bore: 0.01- 0.03mm
 - Maximum play shaft to bore: 0.06mm
- 1.3. Observe the mounting dimensions
 - Length **A** with adapter plate
 - Single stage: **13 ±0.3mm**
 - Multiple stage: **11 ±0.3mm**
 - Length **B** without adapter plate
 - Single stage: **34 ±0.3mm**
 - Multiple stage: **32 ±0.3mm**
- 1.4. Clean and degrease motor shaft and motor pinion
 - Assemble only parts that are completely free of grease
 - Please observe the instructions and specifications of the adhesive manufacturer
- 1.5. Application of adhesive onto motor shaft and motor pinion
 - Apply adhesive into pinion bore and onto motor shaft
 - See detail X and detail Y
- 1.6. Motor pinion installation
 - Install pinion under continuous rotary and longitudinal motion onto motor shaft to evenly distribute the adhesive onto shaft and bore. Apply additional adhesive if required
 - Following the distribution of the adhesive install the motor pinion in accordance with the applicable mounting dimension
- 1.7. Curing of adhesive bond
 - Please observe the specification of the adhesive manufacturer
 - Keep the motor in horizontal position during curing
 - Observe and await firmness of bond before continuing
 - Firmness of Loctite 638 is achieved after approximately 15 to 30 min under optimal conditions
 - Remove excess adhesive from motor shaft and bore if applicable
- 1.8. Secure motor pinion with dowel pin
 - Gear teeth must not be damaged
 - Support the motor with motor pinion during drilling and installation of dowel pin
 - Drill the motor shaft from both sides. The motor pinion is pre-drilled
 - Pin must not protrude after installation

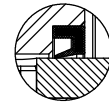
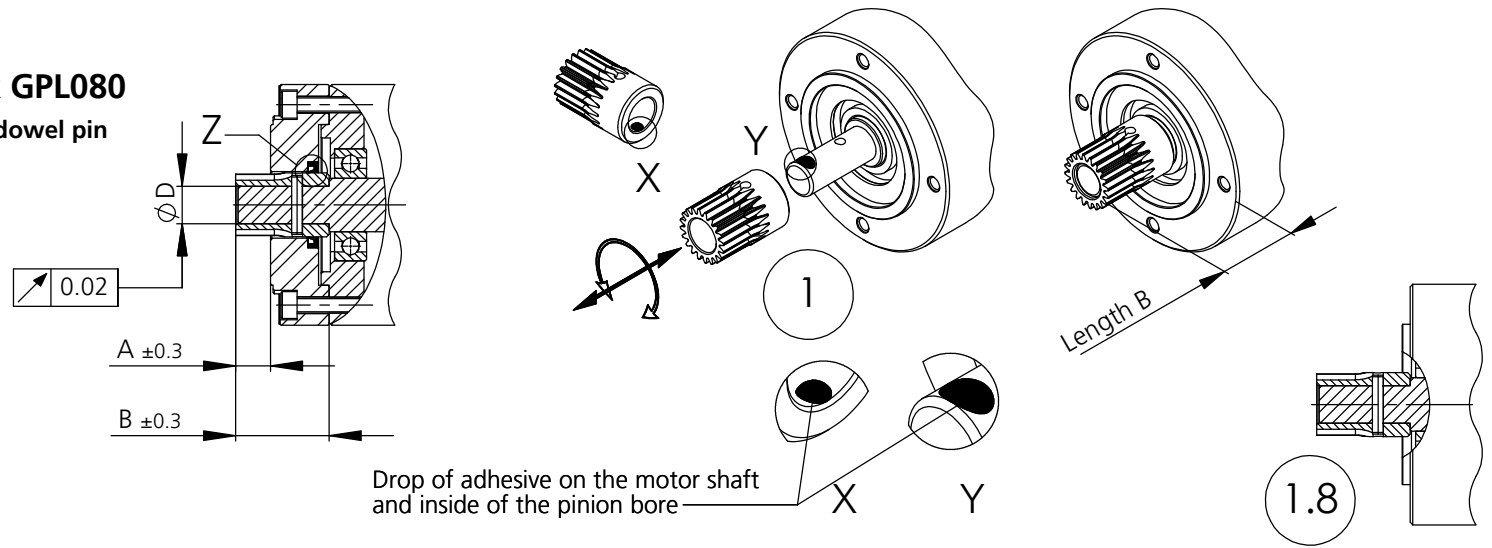

Drop of adhesive on the motor shaft and inside of the pinion bore

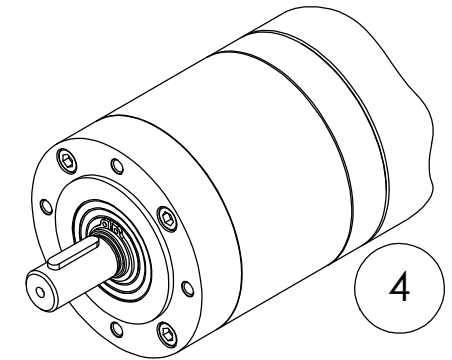
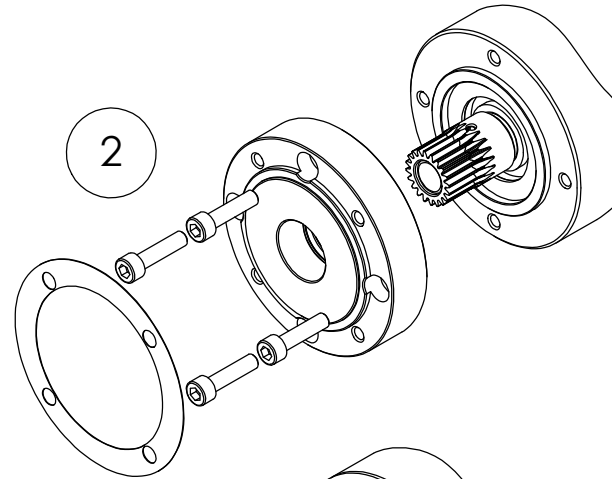

2. Assembly of accessories

- 2.1. Insert radial shaft seal ring (optional) into adapter plate
 - Observe direction of installation. See detail Z
 - Apply a small amount of gear grease onto surface of motor pinion
- 2.2. Mount the adapter plate to the motor. Secure with screws
- 2.3. Install one piece paper gasket onto adapter plate

3. Assembly of Gearbox to Motor

- 3.1. Mount gearbox carefully onto motor
- 3.2. Secure gearbox with supplied screws (M5 / DIN 912) to adapter plate

4. Gearbox run-in

- 4.1. Run the gearbox assembly at no load for 15 min for optimal distribution of the lubrication